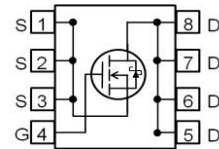
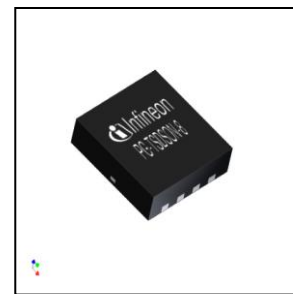

**OptiMOS™ Power-MOSFET**
**Features**

- Optimized for high performance Buck converter
- Monolithic integrated Schottky like diode
- Very low on-resistance  $R_{DS(on)}$  @  $V_{GS}=4.5\text{ V}$
- 100% avalanche tested
- N-channel
- Qualified according to JEDEC<sup>1)</sup> for target applications
- Pb-free lead plating; RoHS compliant
- Halogen-free according to IEC61249-2-21

**Product Summary**

$V_{DS}$	25	V
$R_{DS(on),max}$	1.8	mΩ
$I_D$	40	A
$Q_{OSS}$	23	nC
$Q_G(0V..10V)$	36	nC

**PG-TSDSON-8**  
(fused leads)

Type	Package	Marking
BSZ018NE2LSI	PG-TSDSON-8 (fused leads)	018NE2I

**Maximum ratings, at  $T_j=25\text{ °C}$ , unless otherwise specified**

Parameter	Symbol	Conditions	Value	Unit
Continuous drain current	$I_D$	$V_{GS}=10\text{ V}, T_C=25\text{ °C}$	40	A
		$V_{GS}=10\text{ V}, T_C=100\text{ °C}$	40	
		$V_{GS}=4.5\text{ V}, T_C=25\text{ °C}$	40	
		$V_{GS}=4.5\text{ V}, T_C=100\text{ °C}$	40	
		$V_{GS}=4.5\text{ V}, T_A=25\text{ °C}, R_{thJA}=60\text{ K/W}^2)$	22	
Pulsed drain current <sup>3)</sup>	$I_{D,pulse}$	$T_C=25\text{ °C}$	160	
Avalanche current, single pulse <sup>4)</sup>	$I_{AS}$	$T_C=25\text{ °C}$	20	
Avalanche energy, single pulse	$E_{AS}$	$I_D=20\text{ A}, R_{GS}=25\text{ Ω}$	80	mJ
Gate source voltage	$V_{GS}$		±20	V

<sup>1)</sup> J-STD20 and JESD22

<sup>2)</sup> Device on 40 mm x 40 mm x 1.5 mm epoxy PCB FR4 with 6 cm<sup>2</sup> (one layer, 70 μm thick) copper area for drain connection. PCB is vertical in still air.

<sup>3)</sup> See figure 3 for more detailed information

Maximum ratings, at  $T_j=25\text{ °C}$ , unless otherwise specified

Parameter	Symbol	Conditions	Value	Unit
Power dissipation	$P_{\text{tot}}$	$T_C=25\text{ °C}$	69	W
		$T_A=25\text{ °C}$ , $R_{\text{thJA}}=60\text{ K/W}^2)$	2.1	
Operating and storage temperature	$T_j, T_{\text{stg}}$		-55 ... 150	°C
IEC climatic category; DIN IEC 68-1			55/150/56	

Parameter	Symbol	Conditions	Values			Unit
			min.	typ.	max.	

### Thermal characteristics

Thermal resistance, junction - case	$R_{\text{thJC}}$		-	-	1.8	K/W
Device on PCB	$R_{\text{thJA}}$	6 cm <sup>2</sup> cooling area <sup>2)</sup>	-	-	60	

Electrical characteristics, at  $T_j=25\text{ °C}$ , unless otherwise specified

### Static characteristics

Drain-source breakdown voltage	$V_{(\text{BR})\text{DSS}}$	$V_{\text{GS}}=0\text{ V}$ , $I_{\text{D}}=10\text{ mA}$	25	-	-	V
Breakdown voltage temperature coefficient	$dV_{(\text{BR})\text{DSS}}/dT_j$	$I_{\text{D}}=10\text{ mA}$ , referenced to 25 °C	-	15	-	mV/K
Gate threshold voltage	$V_{\text{GS(th)}}$	$V_{\text{DS}}=V_{\text{GS}}$ , $I_{\text{D}}=250\text{ }\mu\text{A}$	1.2	-	2.0	V
Zero gate voltage drain current	$I_{\text{DSS}}$	$V_{\text{DS}}=20\text{ V}$ , $V_{\text{GS}}=0\text{ V}$ , $T_j=25\text{ °C}$	-	-	0.5	mA
		$V_{\text{DS}}=20\text{ V}$ , $V_{\text{GS}}=0\text{ V}$ , $T_j=125\text{ °C}$	-	2	-	
Gate-source leakage current	$I_{\text{GSS}}$	$V_{\text{GS}}=20\text{ V}$ , $V_{\text{DS}}=0\text{ V}$	-	10	100	nA
Drain-source on-state resistance	$R_{\text{DS(on)}}$	$V_{\text{GS}}=4.5\text{ V}$ , $I_{\text{D}}=20\text{ A}$	-	2.0	2.5	mΩ
		$V_{\text{GS}}=10\text{ V}$ , $I_{\text{D}}=20\text{ A}$	-	1.5	1.8	
Gate resistance	$R_{\text{G}}$		0.4	0.8	1.6	Ω
Transconductance	$g_{\text{fs}}$	$ V_{\text{DS}} >2 I_{\text{D}} R_{\text{DS(on)max}}$ , $I_{\text{D}}=20\text{ A}$	50	100	-	S

Parameter	Symbol	Conditions	Values			Unit
			min.	typ.	max.	

**Dynamic characteristics**

Input capacitance	$C_{iss}$	$V_{GS}=0\text{ V}, V_{DS}=12\text{ V}, f=1\text{ MHz}$	-	2500	3325	pF
Output capacitance	$C_{oss}$		-	1100	1463	
Reverse transfer capacitance	$C_{rss}$		-	110	-	
Turn-on delay time	$t_{d(on)}$	$V_{DD}=12\text{ V}, V_{GS}=10\text{ V}, I_D=30\text{ A}, R_{G,ext}=1.6\ \Omega$	-	5.2	-	ns
Rise time	$t_r$		-	4.8	-	
Turn-off delay time	$t_{d(off)}$		-	25	-	
Fall time	$t_f$		-	3.6	-	

**Gate Charge Characteristics<sup>5)</sup>**

Gate to source charge	$Q_{gs}$	$V_{DD}=12\text{ V}, I_D=30\text{ A}, V_{GS}=0\text{ to }4.5\text{ V}$	-	6.3	8.4	nC
Gate charge at threshold	$Q_{g(th)}$		-	4.1	-	
Gate to drain charge	$Q_{gd}$		-	4.3	6.5	
Switching charge	$Q_{sw}$		-	6.6	-	
Gate charge total	$Q_g$		-	17	23	
Gate plateau voltage	$V_{plateau}$			2.5		V
Gate charge total	$Q_g$	$V_{DD}=12\text{ V}, I_D=30\text{ A}, V_{GS}=0\text{ to }10\text{ V}$	-	36	48	nC
Gate charge total, sync. FET	$Q_{g(sync)}$	$V_{DS}=0.1\text{ V}, V_{GS}=0\text{ to }4.5\text{ V}$	-	15	-	
Output charge	$Q_{oss}$	$V_{DD}=12\text{ V}, V_{GS}=0\text{ V}$	-	23	31	

**Reverse Diode**

Diode continuous forward current	$I_S$	$T_C=25\text{ }^\circ\text{C}$	-	-	40	A
Diode pulse current	$I_{S,pulse}$		-	-	160	
Diode forward voltage	$V_{SD}$	$V_{GS}=0\text{ V}, I_F=7\text{ A}, T_j=25\text{ }^\circ\text{C}$	-	0.55	0.7	V
Reverse recovery charge	$Q_{rr}$	$V_R=15\text{ V}, I_F=7\text{ A}, di_F/dt=400\text{ A}/\mu\text{s}$	-	5	-	nC

<sup>4)</sup> See figure 13 for more detailed information

<sup>5)</sup> See figure 16 for gate charge parameter definition

**1 Power dissipation**

$P_{tot}=f(T_C)$

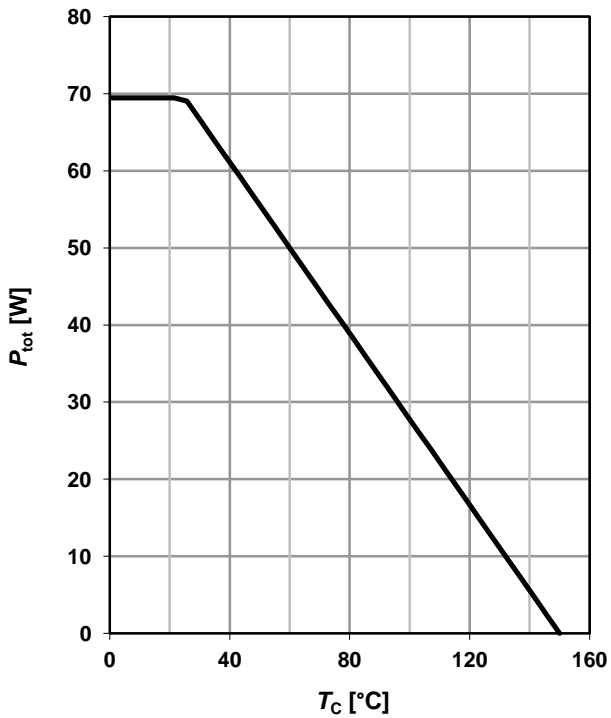

**2 Drain current**

$I_D=f(T_C); V_{GS} \geq 10\text{ V}$

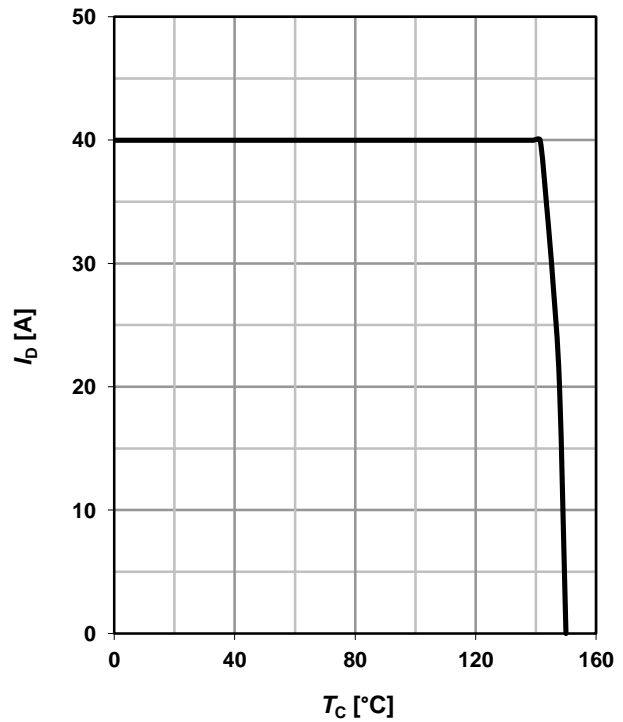

**3 Safe operating area**

$I_D=f(V_{DS}); T_C=25\text{ °C}; D=0$

parameter:  $t_p$

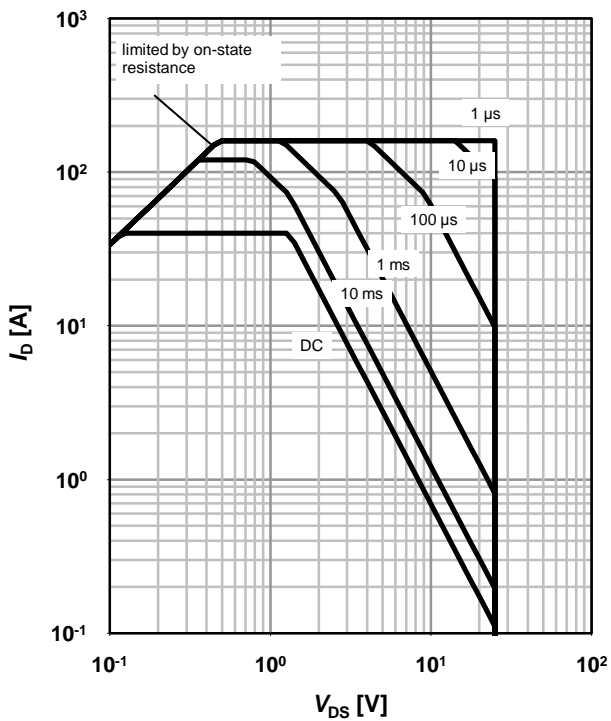

**4 Max. transient thermal impedance**

$Z_{thJC}=f(t_p)$

parameter:  $D=t_p/T$

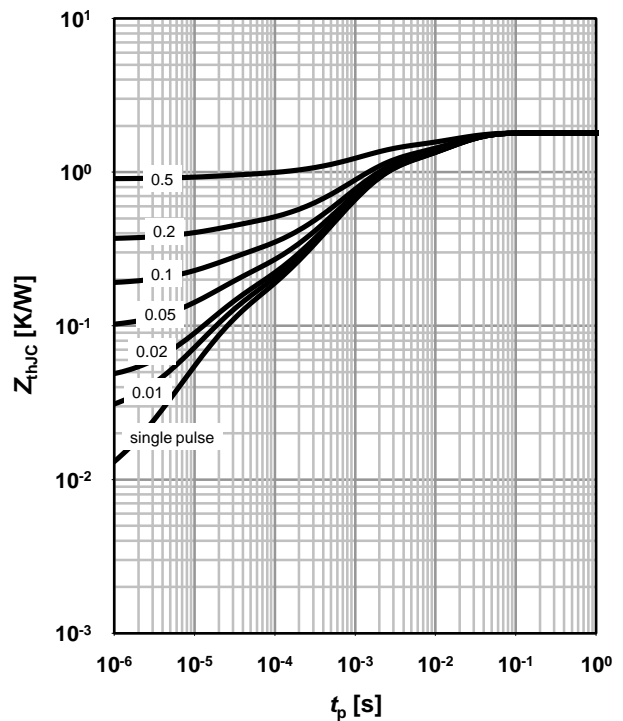

**5 Typ. output characteristics**

$I_D = f(V_{DS}); T_j = 25\text{ °C}$

parameter:  $V_{GS}$

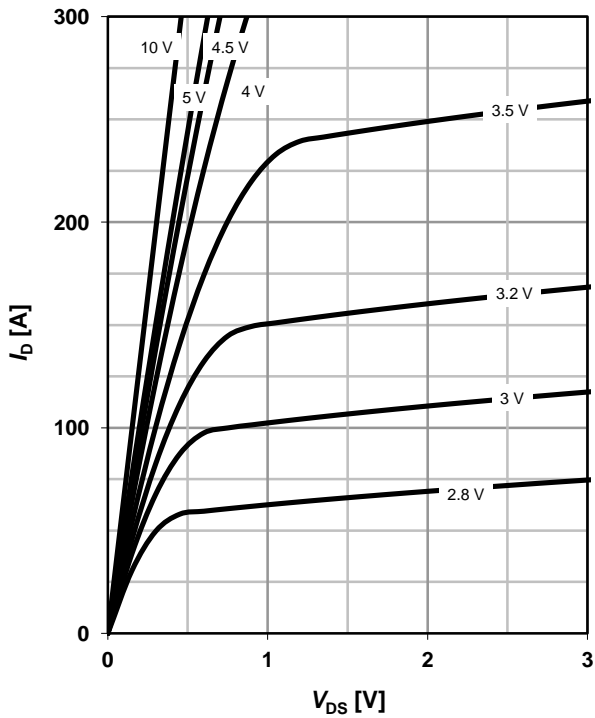

**6 Typ. drain-source on resistance**

$R_{DS(on)} = f(I_D); T_j = 25\text{ °C}$

parameter:  $V_{GS}$

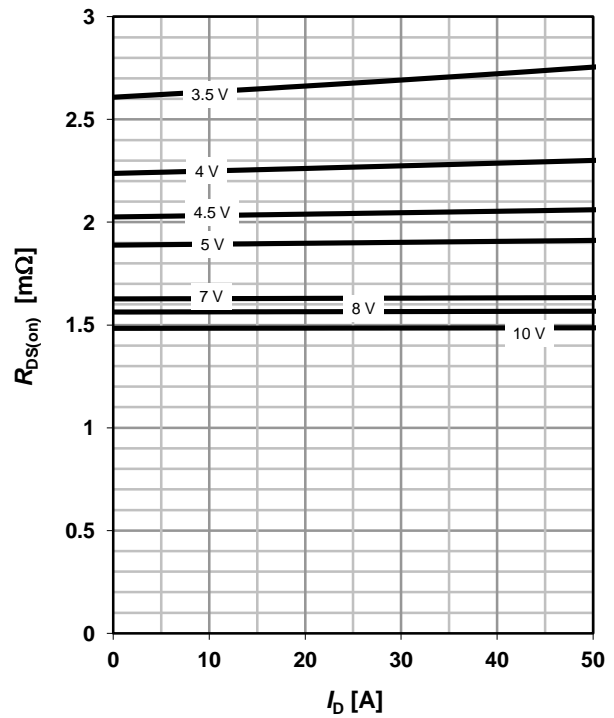

**7 Typ. transfer characteristics**

$I_D = f(V_{GS}); |V_{DS}| > 2|I_D|R_{DS(on)max}$

parameter:  $T_j$

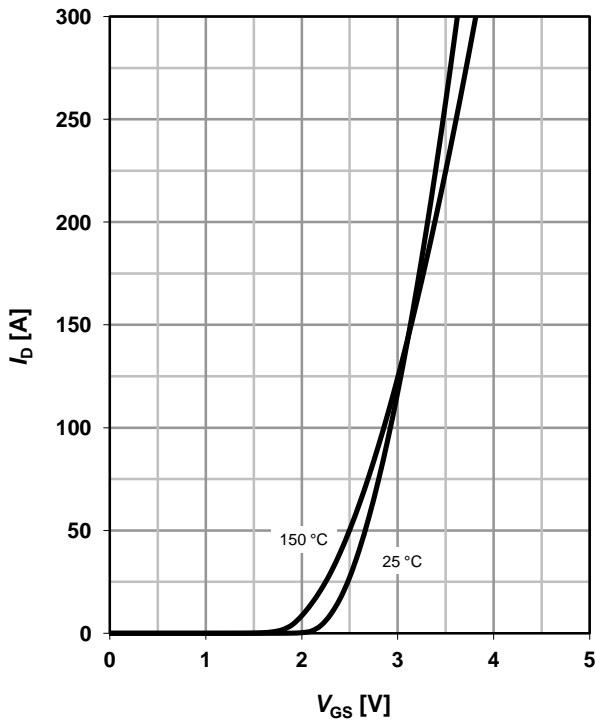

**8 Typ. forward transconductance**

$g_{fs} = f(I_D); T_j = 25\text{ °C}$

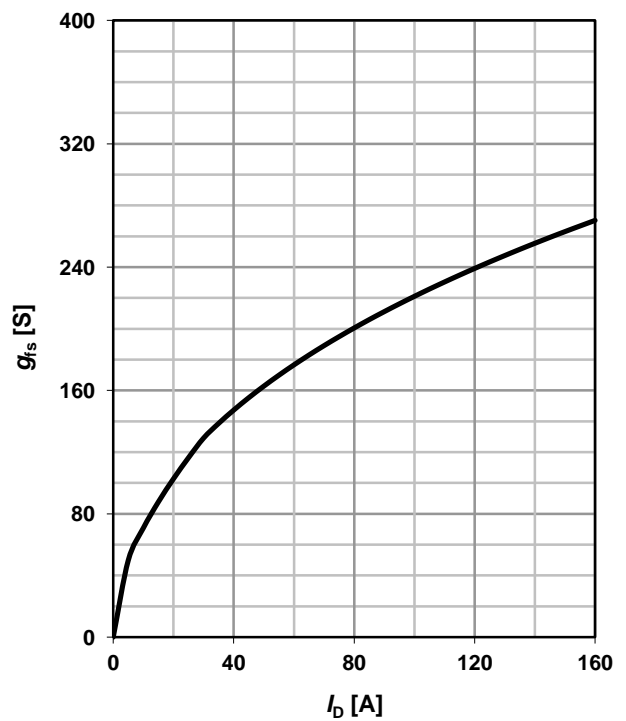

**9 Drain-source on-state resistance**

$R_{DS(on)}=f(T_j); I_D=20\text{ A}; V_{GS}=10\text{ V}$

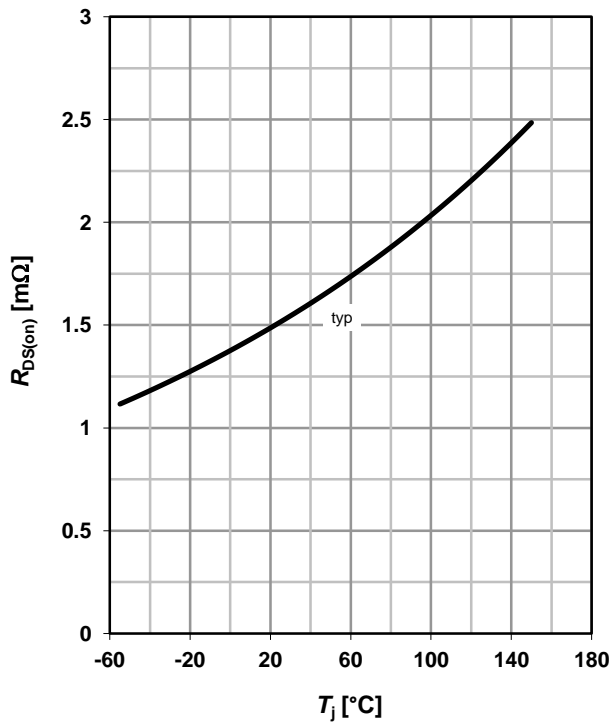

**10 Typ. gate threshold voltage**

$V_{GS(th)}=f(T_j); V_{GS}=V_{DS}; I_D=10\text{ mA}$

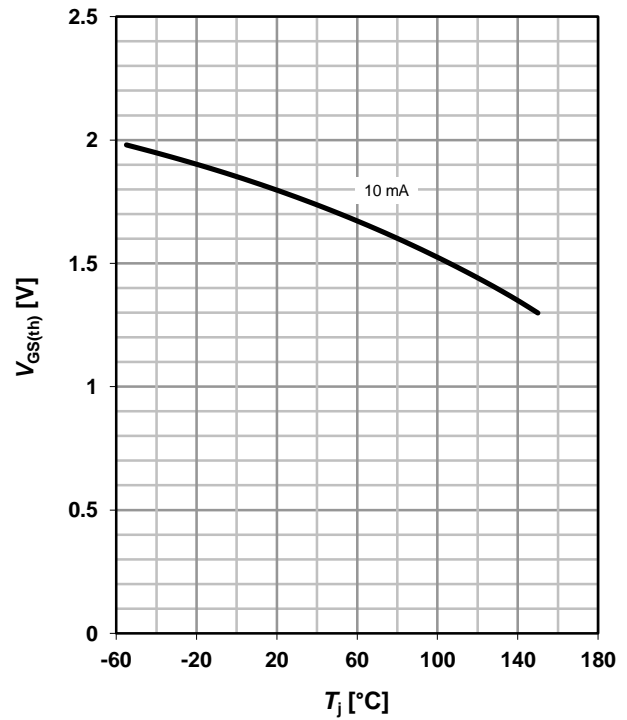

**11 Typ. capacitances**

$C=f(V_{DS}); V_{GS}=0\text{ V}; f=1\text{ MHz}$

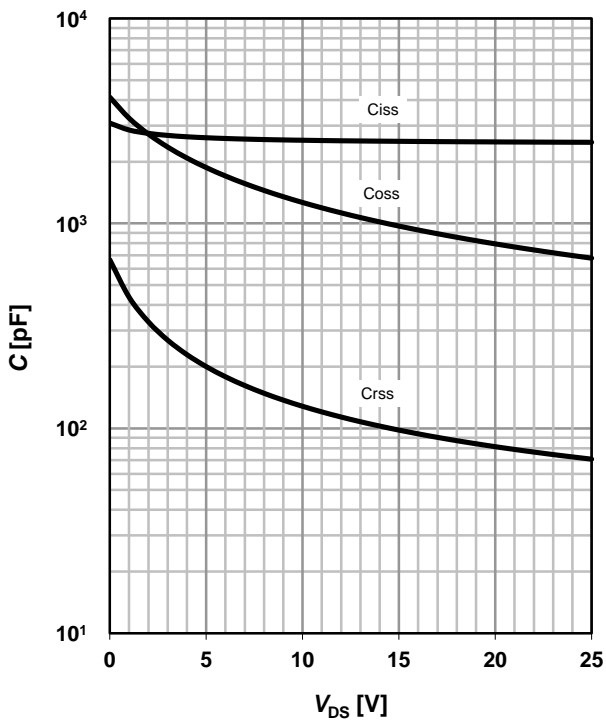

**12 Forward characteristics of reverse diode**

$I_F=f(V_{SD})$

parameter:  $T_j$

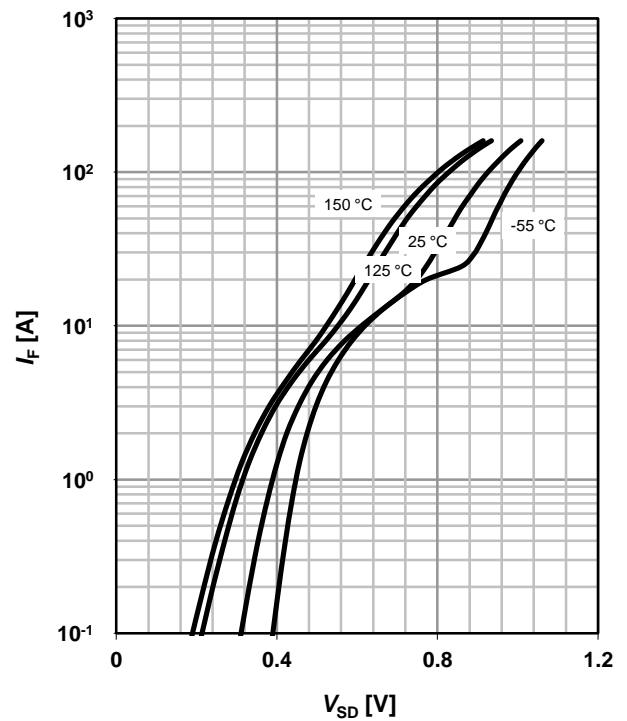

**13 Avalanche characteristics**

$I_{AS}=f(t_{AV}); R_{GS}=25 \Omega$

parameter:  $T_{j(start)}$

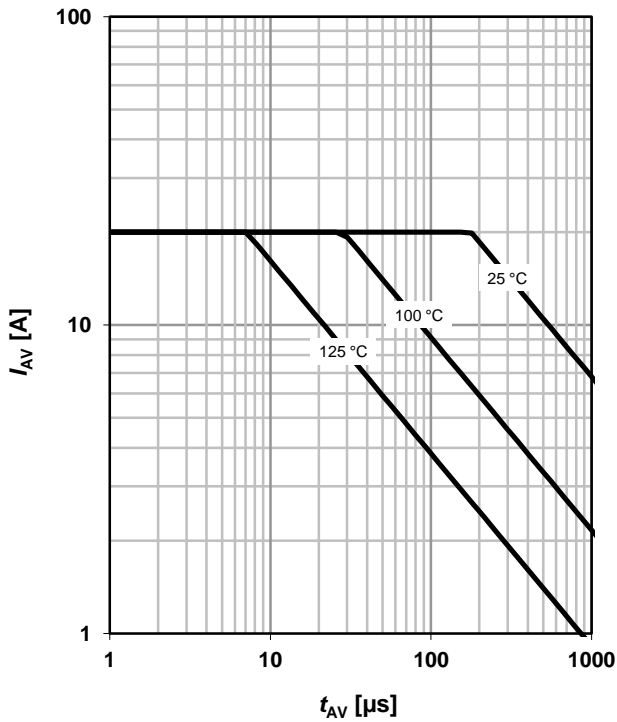

**14 Typ. gate charge**

$V_{GS}=f(Q_{gate}); I_D=30 \text{ A pulsed}$

parameter:  $V_{DD}$

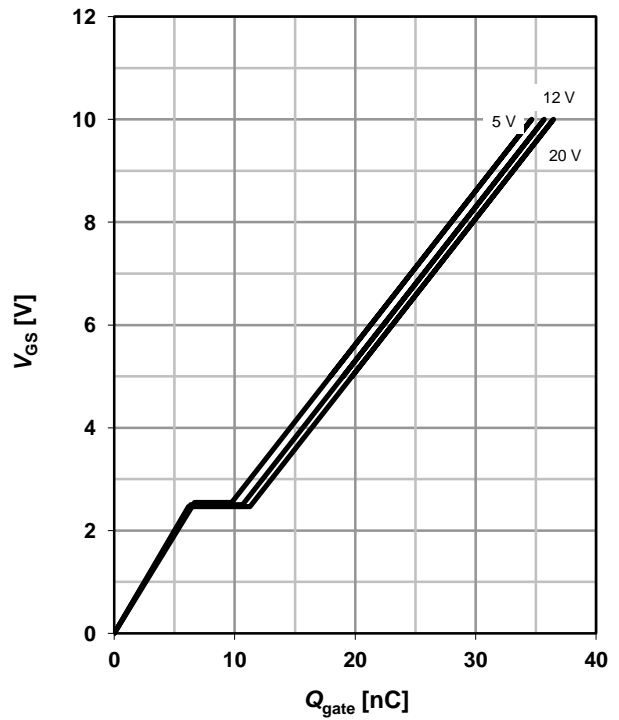

**15 Typ. drain-source leakage current**

$I_{DSS}=f(V_{DS}); V_{GS}=0 \text{ V}$

parameter:  $T_j$

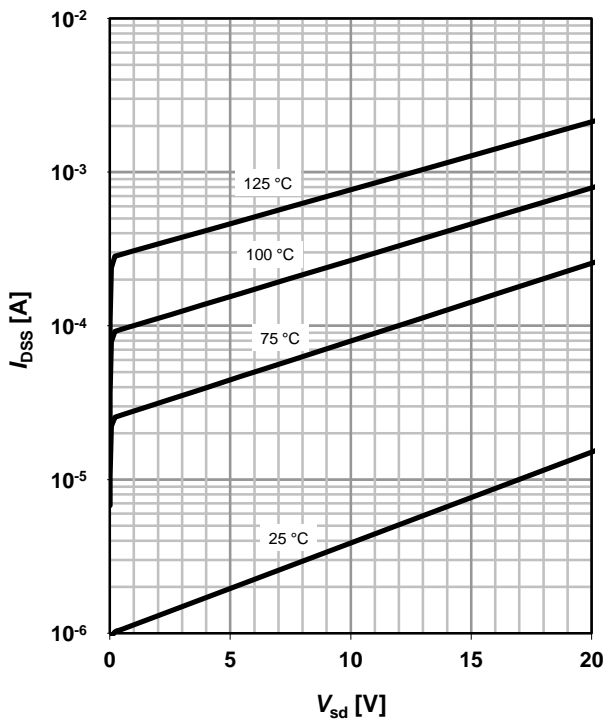

**16 Gate charge waveforms**

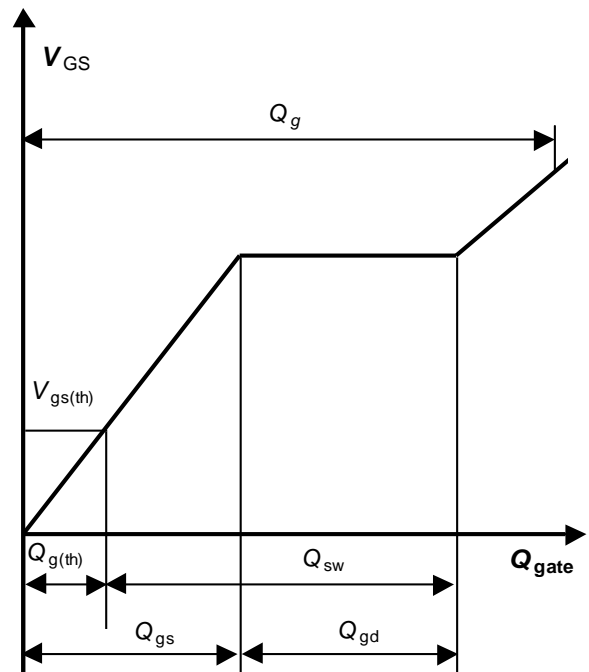

Package Outline

PG-TSDSON-8 (fused leads)

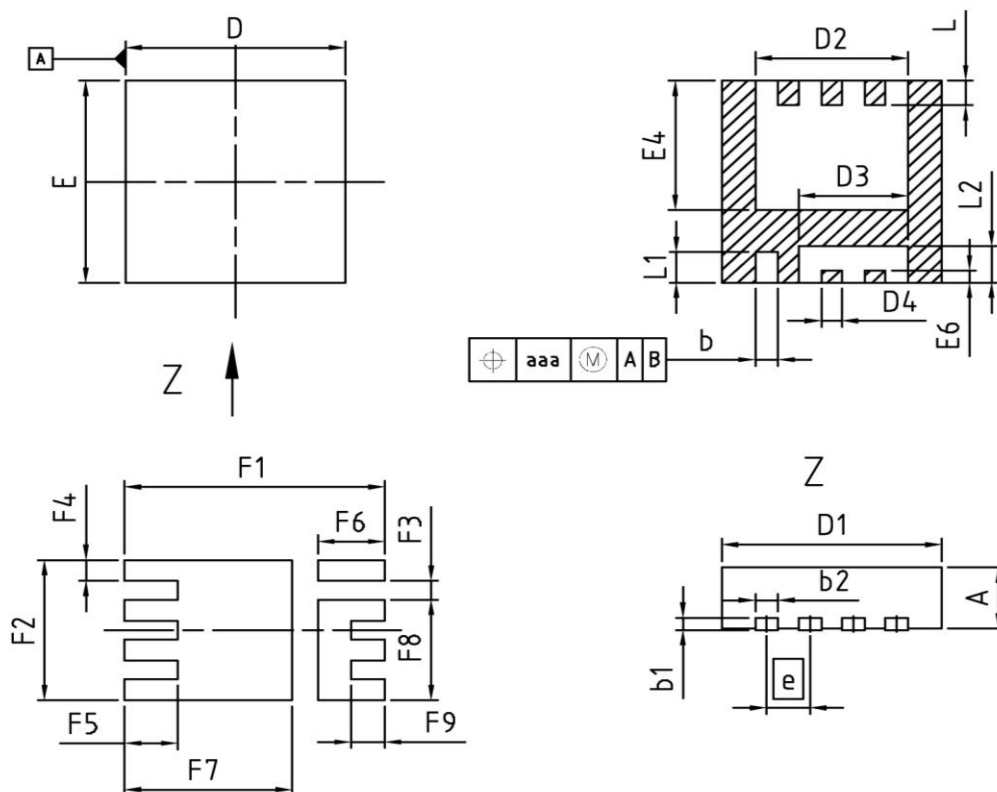

DIM	MILLIMETERS		INCHES	
	MIN	MAX	MIN	MAX
A	0.90	1.10	0.035	0.043
b	0.24	0.44	0.009	0.017
b1	0.10	0.30	0.004	0.012
b2	0.24	0.44	0.009	0.017
D=D1	3.20	3.40	0.126	0.134
D2	2.19	2.39	0.086	0.094
D3	1.54	1.74	0.061	0.069
D4	0.21	0.41	0.008	0.016
E	3.20	3.40	0.126	0.134
E4	2.01	2.21	0.079	0.087
E6	0.10	0.30	0.004	0.012
e	0.65 (BSC)		0.026 (BSC)	
N	8		8	
L	0.30	0.51	0.012	0.020
L1	0.40	0.70	0.016	0.028
L2	0.50	0.70	0.020	0.028
aaa	0.25		0.010	
F1	3.90		0.154	
F2	2.29		0.090	
F3	0.31		0.012	
F4	0.34		0.013	
F5	0.80		0.031	
F6	1.00		0.039	
F7	2.51		0.099	
F8	1.64		0.065	
F9	0.50		0.020	

**DOCUMENT NO.**  
Z8B00158553

**SCALE** 0 2.5 5mm

**EUROPEAN PROJECTION**

**ISSUE DATE**  
27-12-2010

**REVISION**  
02



**Published by**  
**Infineon Technologies AG**  
**81726 Munich, Germany**  
**© 2011 Infineon Technologies AG**  
**All Rights Reserved.**

**Legal Disclaimer**

The information given in this document shall in no event be regarded as a guarantee of conditions or characteristics. With respect to any examples or hints given herein, any typical values stated herein and/or any information regarding the application of the device, Infineon Technologies hereby disclaims any and all warranties and liabilities of any kind, including without limitation, warranties of non-infringement of intellectual property rights of any third party.

**Information**

For further information on technology, delivery terms and conditions and prices, please contact the nearest Infineon Technologies Office ([www.infineon.com](http://www.infineon.com)).

**Warnings**

Due to technical requirements, components may contain dangerous substances. For information on the types in question, please contact the nearest Infineon Technologies Office.

Infineon Technologies components may be used in life-support devices or systems only with the express written approval of Infineon Technologies, if a failure of such components can reasonably be expected to cause the failure of that life-support device or system or to affect the safety or effectiveness of that device or system. Life support devices or systems are intended to be implanted in the human body or to support and/or maintain and sustain and/or protect human life. If they fail, it is reasonable to assume that the health of the user or other persons may be endangered.